

Super Silent Blowers

E1033H



97×95×33
(3.8"×3.7"×1.3")
Max. airflow: 1.14 m³/min
Max. static pressure: 500 Pa
Mass: 140 g (~8), 160 g (~A), 170 g (~B)

Fan model code

- E1033H12B5AM-04
- E1033H12B6AM-04
- E1033H12B7AP-00
- E1033H12B7AS-00
- E1033H12B7AZ-00
- E1033H12B8AP-00
- E1033H12B8AS-00
- E1033H12B8AZ-00
- E1033H12BAAP-00
- E1033H12BAAS-00
- E1033H12BAAZ-00
- E1033H24B5AM-04
- E1033H24B6AP-00
- E1033H24B6AS-00
- E1033H24B6AZ-00
- E1033H24B7AP-00
- E1033H24B7AS-00
- E1033H24B7AZ-00
- E1033H24B8AP-00
- E1033H24B8AS-00
- E1033H24B8AZ-00
- E1033H24BAAP-00
- E1033H24BAAS-00
- E1033H24BAAZ-00

Standard specification

Max. Airflow m ³ /min	Max. Static Pressure CFM	Pa	inH ₂ O	Noise dB	Speed min ⁻¹	Voltage spec. V		Current mA		Model Code	Operating Temp. Range °C
						Rating	Operating Range	Rating	Starting		
1.14	40	500	2.01	58	4850	12	8.4-13.2	1250	2100	E1033H12BAAZ-00	-20 ~ +60
						24	16-26.4	630	1850	E1033H24BAAZ-00	
0.85	30	320	1.29	51	3450	12	4.5-13.2	770	1950	E1033H12B8AZ-00	-20 ~ +70
						24	10-26.4	390	940	E1033H24B8AZ-00	
0.76	27	260	1.05	48	3100	12	5-13.2	590	1260	E1033H12B7AZ-00	-20 ~ +70
						24	10-26.4	300	710	E1033H24B7AZ-00	
0.64	23	185	0.74	43	2600	12	5-13.2	400	820	E1033H12B6AM-04	-20 ~ +70
						24	10-26.4	220	400	E1033H24B6AZ-00	
0.53	19	120	0.48	39	2200	12	5-13.8	250	500	E1033H12B5AM-04	-20 ~ +70
						24	10-26.4	120	260	E1033H24B5AM-04	

● Figures in the table are average measured values. Please request the product delivery specification when preparing a purchase specification.
● The characteristics are the values at rated voltage (12 V or 24 V), and normal temperature and humidity.

General specification

Materials Used	Venturi: ABS and PBT synthetic resins Impeller: ABS and PBT synthetic resins Bearing: Both side shielded ball bearing
Motor	Brushless DC motor, Protection type: Current shut off by detecting lock state, automatically reset
Common Elec. Spec.	See pages G-11, G-12, G-13.
Standard Carton	50 to a carton of (450 x 380 x 220) mm, mass 8 kg

Standard airflow and static pressure characteristics (At rated voltage)

[By double chamber method]

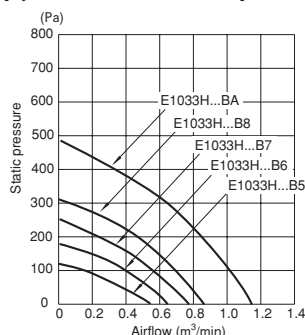

Wiring connection diagram

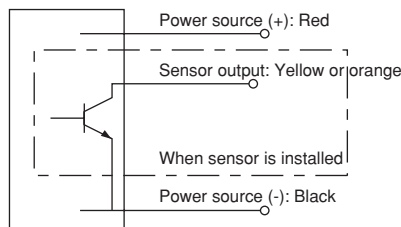

External dimensions in mm (inches)

● Lead wire type (E1033H)

Lead wire spec. AWG24 UL3266
Color (+) Red
(-) Black

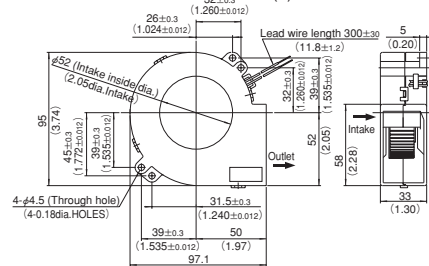

● Terminal type (E1033H□□B□AM-04)

(Note: Multi-sensor products with lock detection or pulse output, depending on the connection cord.)

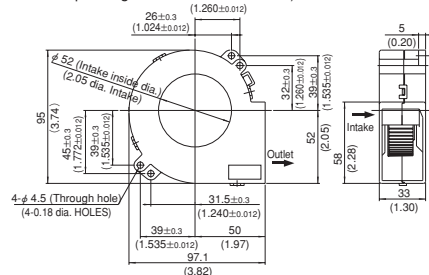

Accessory cord (DCLD030ZT-ZZ01)

This cord is supplied with the terminal type of (-04). Cords for S and P sensors also optionally available. (See page G-66.)

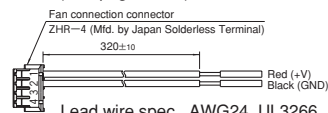

Lead wire spec. AWG24 UL3266

Lead wire ends are sheathed to protect the conductors. (Sheath peeling dimension 10 ±5)

- Terminal output
- 1: (+)
- 2: (-) GND
- 3: S sensor output (Lock detection)
- 4: P sensor output (Pulse output)

Super silent blower with sensor

Rated Vol.	Model Code				
12 V	E1033H12B5AM-04 (note 1)	E1033H12B6AM-04 (note 1)	E1033H12B7AS-00	E1033H12B8AS-00	E1033H12BAAS-00
			E1033H12B7AP-00	E1033H12B8AP-00	E1033H12BAAP-00
24 V	E1033H24B5AM-04 (note 1)	E1033H24B6AS-00	E1033H24B7AS-00	E1033H24B8AS-00	E1033H24BAAS-00
		E1033H24B6AP-00	E1033H24B7AP-00	E1033H24B8AP-00	E1033H24BAAP-00

- AM-04 becomes a lock detection sensor (S) type or pulse sensor (P) type in accordance with the connector connection method.
- Note 1: Purchase a sensor output cord (See page G-66) optionally available or the customer shall provide a cord with equivalent specifications if a sensor function is desired.
- NIDEC SERVO can meet many of your requirements for customization, such as special connectors, other sensors not listed above, variable speed specifications, and other modifications. Please contact NIDEC SERVO during your product planning and development stage.
- The listed products are registered in the following overseas standards files, UL/cUL: E48889, TUV: R50004410
- PWM (pulse width modulation) allowing for variable speed control is available in some models (reference the G-51 spec).

Fan model code

D0925C12B8ZP-00
D0925C24B8ZP-00
D1238B48B7ZP-00
D1751M24B4ZP-00
D1751M24B5ZP-00
D1751M24B6ZP-00
D1751M24B7ZP-00
D1751M24B8ZP300
D1751M24B9ZP300
D1751M48B4ZP-00
D1751M48B5ZP-00
D1751M48B6ZP-00
D1751M48B7ZP-00
D1751M48B8ZP-00
D1751M48B9ZP-00
D1751S24B4ZP-00
D1751S24B5ZP-00
D1751S24B6ZP-00
D1751S24B6ZQ-00
D1751S24B7ZP-00
D1751S24B8ZP300
D1751S24B9ZP300
D1751S48B4ZP-00
D1751S48B5ZP-00
D1751S48B6ZP-00
D1751S48B7ZP-00
D1751S48B8ZP-00
D1751S48B9ZP-00
D1751S24B4ZR-13
E1033H12B8ZS-00
E1033H12BAZP-00
E1033H24BAZS-00
E1033H24BAZP-00
E2271Z24B5YP-00
E2271Z48B7ZP-00

Lineup of PWM variable-speed semi-standard products

● A PWM signal from the customer equipment is input to the control line (blue) of the fan motor for variable-speed operation of fans and blowers. (Input and noise can be reduced when the internal temperature of the customer equipment is low, such as during idling.)

- Sizes
Axial fans: □60 mm~□172 mm
Blower: □70 mm~φ220 mm

Characteristics for reference

(The characteristics are typical characteristics and their curves will differ, depending on the particular model)

- Standard values for PWM control signal - speed specification (at rated voltage, open, and normal temperature and humidity)

I _{out}	1 mA MAX.
V _{out}	5 V MAX.
V _{Losat}	0.4 MAX.
Freq.	500 Hz~5000 Hz

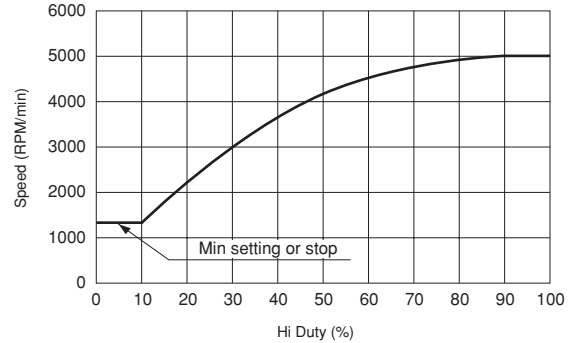
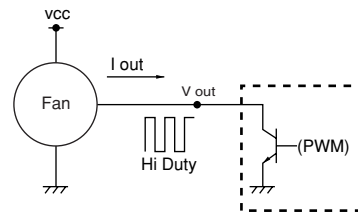

Semi-standard products (Products in regular production)

Size	Model Code	Max. Airflow		Max. Static Pressure		Noise dB	Speed min ⁻¹		Voltage Spec. V		Operating Temp. Range °C
		m ³ /min	CFM	Pa	inH ₂ O		Max.	Min.	Rating	Operating Range	
□92×25mm	D0925C12B8ZP-00	2	71	67	0.27	40	4450	1000	12	10.2-13.2	-20 ~ 60°C
	D0925C24B8ZP-00										
□120×38mm	D1238B48B7ZP-00	4.4	155	170	0.68	54	4000	1250	48	40.8-55.2	-20 ~ 70°C
	D1751M24B9ZP300										
φ172×150×51mm	D1751M48B9ZP-00	14.2	501	580	2.33	75	6800	3200	24	16-28	-20 ~ 70°C
	D1751M24B8ZP300										
	D1751M48B8ZP-00	12.7	448	510	2.05	72	6100	2600	48	36-60	
	D1751M24B7ZP-00										
	D1751M48B7ZP-00	11.4	402	410	1.65	69	5400	1500	24	12-27.6	
	D1751M24B6ZP-00										
	D1751M48B6ZP-00	10.2	360	315	1.27	64	4800	1000	48	36-60	
	D1751M24B5ZP-00										
	D1751M48B5ZP-00	9	318	260	1.04	61	4200	1000	48	36-60	
	D1751M24B4ZP-00										
	D1751M48B4ZP-00	8	282	205	0.82	57	3800	1000	24	12-27.6	
	D1751S24B9ZP300										
φ172×51mm	D1751S48B9ZP-00	14.2	501	640	2.57	68	6800	3200	48	36-60	-20 ~ 60°C
	D1751S24B8ZP300										
	D1751S48B8ZP-00	12.7	448	520	2.09	65	6100	2600	48	36-60	
	D1751S24B7ZP-00										
	D1751S48B7ZP-00	11.4	402	435	1.75	62	5400	1500	24	12-27.6	
	D1751S24B6ZP-00										
	D1751S48B6ZP-00	10.2	360	335	1.35	59	4800	1000	48	36-60	
	D1751S24B5ZP-00										
	D1751S48B5ZP-00	9	318	270	1.08	56	4200	1000	48	36-60	
	D1751S24B4ZP-00										
	D1751S48B4ZP-00	8	282	220	0.88	53.5	3800	1000	24	12-27.6	
	D1751S24B4ZR-13										
※	D1751S24B4ZR-13	8	282	230	0.92	53.5	3800	1500	24	20.4-27.6	
97×95×33mm (Blowers)	E1033H12B8ZS-00	0.85	30	320	1.29	51	3450	1250	12	10.8-13.2	-20 ~ 70°C
	E1033H12BAZP-00										
	E1033H24BAZP-00	1.14	40	500	2.01	58	4850	1800	24	21.6-26.4	
	E1033H24BAZS-00										
φ220×71mm (Blowers)	E2271Z48B7ZP-00	18.1	639	600	2.41	74	3200	1000	48	36-57	-20 ~ 60°C
	E2271Z24B5YP-00										
		14.7	519	470	1.89	66	2650	530	24	21.6-26.4	-20 ~ 40°C

※: The D1751S24B4ZR-13 is a FFU (Fan Filter Unit) product. Only this version has 'voltage speed control' whereby speed is varied by control voltage.

- Aside from the above models, please see also the high pressure, variable speed G series fans. Details may be found in specs G-31 to G-36.
- The lineup of variable-speed fans and blowers will be expanded regularly. Visit the NIDEC SERVO Website for information on the latest lineup.
- Direct your inquiry to NIDEC SERVO for connector termination to lead wires, for sensor specifications other than those contained in the catalog and for variable speed specifications. (Products tailored to voltage command control and resistance value command control are also available)
- To ensure correct installation and smooth operation please obtain a drawing for approval or reference drawing from NIDEC SERVO Co.

F60P Guard (Mass 4 g)

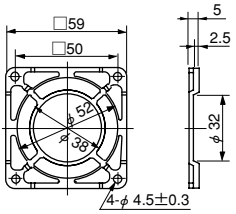

Material: Polycarbonate (black)
UL94V-2

F60UL Guard (Mass 12 g)

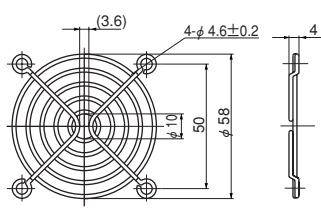

Material: Mild steel wire 1.6 dia.
Surface treatment:
Nickel chromium plating

F80UL Guard (Mass 14 g)

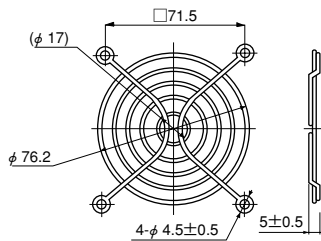

Material: Mild steel wire 1.6 dia.
Surface treatment:
Nickel chromium plating

F92UL Guard (Mass 16 g)

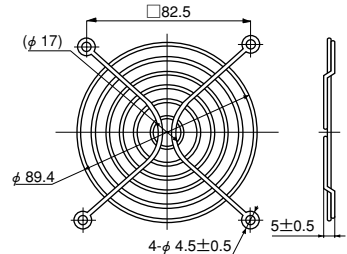

Material: Mild steel wire 1.6 dia.
Surface treatment:
Nickel chromium plating

F120UL Guard (Mass 29 g)

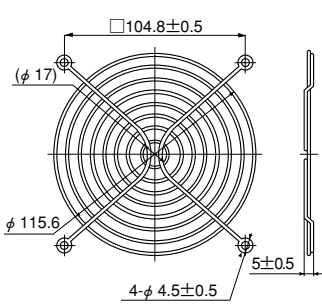

Material: Mild steel wire 1.6 dia.
Surface treatment:
Nickel chromium plating

F127UL Guard

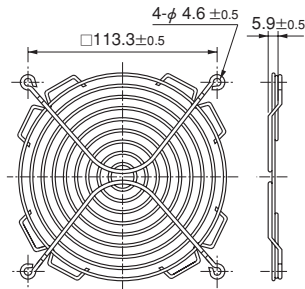

Material: Mild steel wire 1.6 dia.
Surface treatment:
Nickel chromium plating

GUARD 172

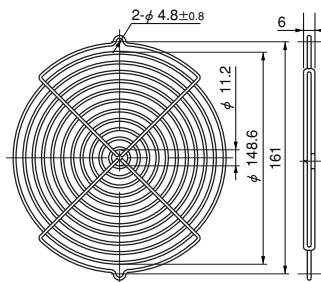

Material: Mild steel wire 2 dia.
Surface treatment:
Nickel chromium plating

F180UL Guard

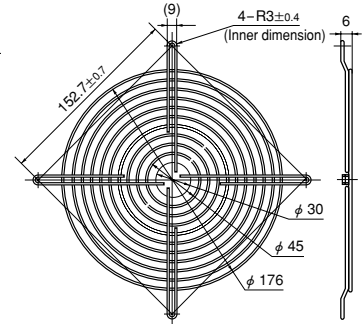

Material: Mild steel wire 1.6 dia.
Surface treatment:
Nickel chromium plating

F200UL Guard (Mass 82 g)

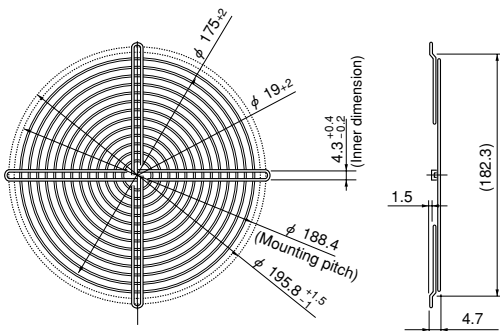

Material: Mild steel wire 1.6 dia.
Surface treatment:
Nickel chromium plating

SCN Guard (Mass 55 g)

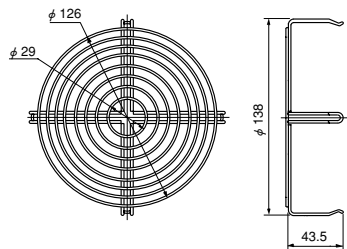

Material: Mild steel wire 1.6 dia.
Surface treatment:
Nickel chromium plating

• Guard special for intake side of
SCN (metal venturi) fans.

List of mating fan series

Guard	F60P	F60UL	F80UL	F92UL	F120UL	F127UL	GUARD 172	F180UL	F200UL	SCN
SCN					○*1					○*2
AC Axial Fans			○	○						
VE			○							
WE				○						
KA				○						
CU					○					
CN					○					
MA							○			
PA							○			
DC Axial Fans	○	○	○	○	○	○	○	○	○	○
TUDC	○	○								
PUDC			○							
KUDC				○						
DO925C				○						
KLDC				○						
CUDC					○					
D1225C					○					
DC Axial Fans										
CNDC					○					
D1238T					○					
D1238B					○					
D1338B						○				
D1338S						○				
D1751M							○			
D1751S							○			
G0638D		○								
G0838C			○							
G0938B				○						
G1238B					○					
G1751M								○		

*1: Can be installed only on outlet side. *2: Can be installed only on intake side.
All guards conform to the UL standard when combined with NIDEC SERVO fans.
The installation of a filter, guard and other accessories will constitute a ventilating load, reducing the airflow. Select a suitable guard, taking into consideration the increase in air resistance. (See Figs. 12 and 13 on page G-7.)

Filter

3-piece set

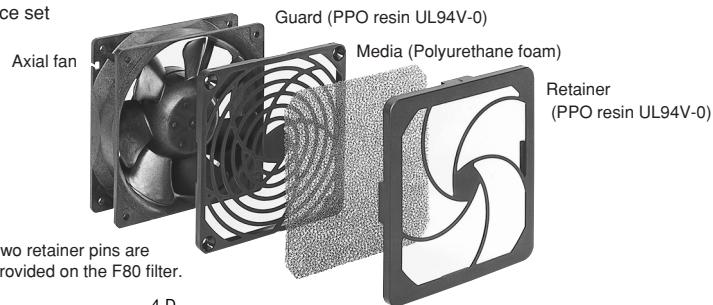

Note: Two retainer pins are provided on the F80 filter.

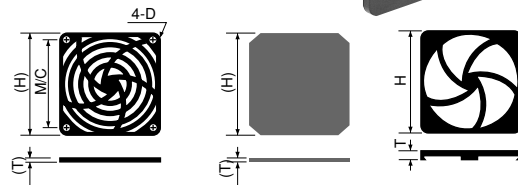

List of mating fan series

Filter	F80	F92	F120
PUDC	○		
KUDC		○	
D0925C		○	
KLDC		○	
CUDC			○
D1225C			○
CNDC			○
D1238T			○
D1238B			○
G0838C	○		
G0938B		○	
G1238B			○

Filter	F80	F92	F120
VE	○		
WE		○	
KA		○	
CU			○
CN			○

Component (Model Code)	H	T	M/C	D
F80 Filter	83.6	10	71.5	φ 3.8
F92 Filter	96.5	10	82.5	φ 3.8
F120 Filter	123.7	10.7	104.8	φ 4.6

Flange spacer

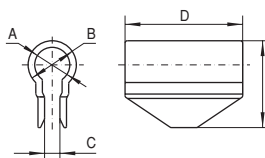

Component (Model Code)	A mm	B mm	C mm	D mm	E mm	Mating Model Code
Flange Spacer PUDC (※)	5	8	2	17	14.5	KUDC,PUDC
Flange Spacer CUDC (※)	8	11	3.5	15	19.8	CUDC
Flange Spacer CNDC	8	11	3.5	28	19.8	CNDC

※Ribbed venturis (PUDC-R, CUDC-R) are available for PUDC and CUDC.

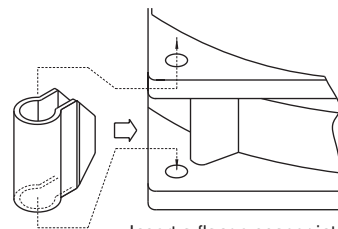

Insert a flange spacer into the ribs of a venturi.

(Installing a flange spacer)

Inlet ring

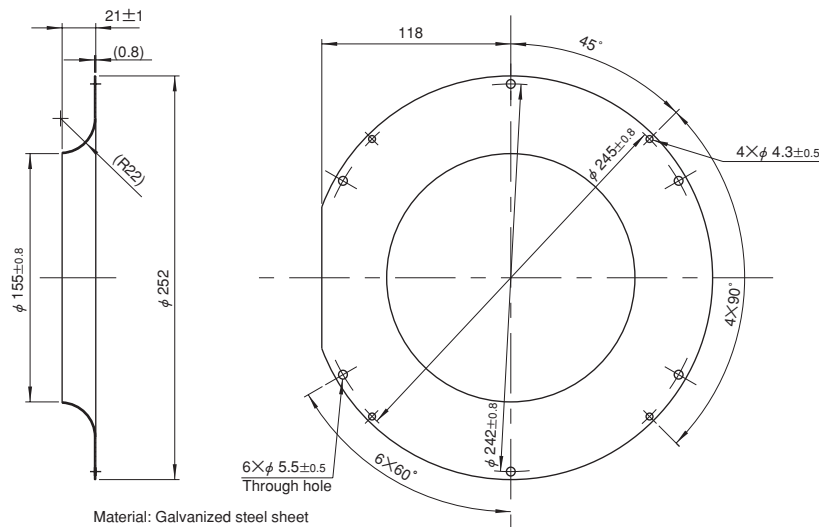

Component (Model Code)	Mating Model Code
E2271 Inlet ring	E2271Z

DC axial fans & blowers with sensors

The DC fans and blowers of NIDEC SERVO have a function to send an alarm signal when the fan motor revolutions slow down. Several systems are used to cut off the system power supply by this alarm signal, with three types of sensors available. Select the right type of sensor in accordance with the purpose of use. The lead wire for the sensor is yellow. The output type is an open collector output for all three types.

■ Sensor type

1. Lock detection type (Product code: S)

The output signal indicates an [L] state (transistor is ON) while the propeller is rotating, changing to an [H] state (transistor is OFF) less than five seconds after the propeller stops rotating. The propeller automatically restarts operation within five seconds when the lock is unlocked. ([H] → [L] 5 s). If the pull-up voltage is live, the [H] state (transistor is OFF) will engage in less than five seconds, even when the power is turned off.

- Specification: VCE = 28 V max (55.2 V max for 48 V products)
IC = 5 mA max
(VCE (SAT) = 0.4 V max)
- Output waveform

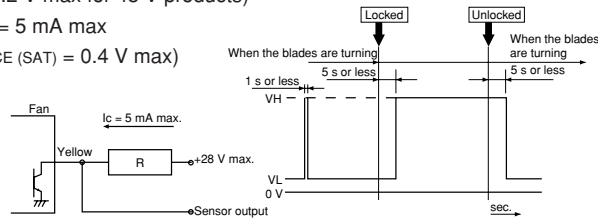

※When the power is turned on, the state sometimes becomes high [H] for several hundred ms.

2. Pulse output type (Product code: P)

A rectangular wave of two pulses will be output for each turn of the propeller while the propeller is rotating, outputting two types of signal depending on the propeller position when the propeller is locked. (See the note below ※)

- Specification: VCE = 28 V max (55.2 V max for 48 V products)
IC = 5 mA max
(VCE (SAT) = 0.4 V max)
- Output waveform

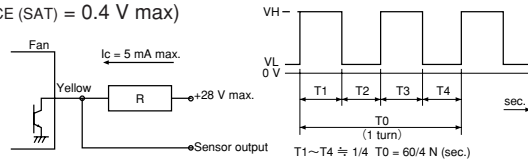

※Output signal waveform when the fan is stopped: The following two types of waveform are output, depending on the blade position when the propeller is stopped:
Pulse outputs of High - constant or restart timing (0.05 Hz to 2 Hz).

3. Speed detection type (Product code: Q)

The output signal indicates the [H] state when the propeller revolutions are slower than the preset speed, changing to the [L] state when the propeller revolutions exceed the reset speed.

[Products with a reversed output waveform are also available, suitable for a wired OR connection when several fans are installed. Contact NIDEC SERVO for further information. {Former code: SQ, new code (15 - digit code products): R}]

- Specification: VCE = 28 V max (55.2 V max for 48 V products)
IC = 5 mA max
(VCE (SAT) = 0.4 V max at 5 mA)
- Output waveform

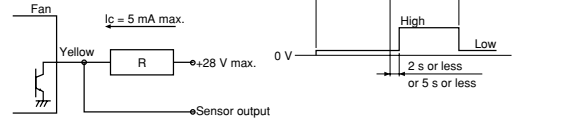

Note: The output waveform for type SQ (R) will be reversed. The speed setting for the alarm output is about half the rated speed. For more detailed information, please request a product delivery specification from NIDEC SERVO.

AC fans with sensors

By equipping the motor with a rotation detection function, the AC fans of NIDEC SERVO have a system to send an alarm signal when the fan motor revolutions slow down and to cut off the system power supply. In 1980, NIDEC SERVO developed a system to output an alarm signal by detecting the lowering of generated voltage by installing a tachometer generator with the cooling fan and this system has since been incorporated in NIDEC SERVO products. The output type of the alarm signal is an open collector output.

Type	Tachometer generator type			
Sensor output operation	Open collector transistor, permissible sync Current: 50 mA max. Permissible imposed voltage: DC 40 V max. Permissible power consumption: 1.5 W max. (at 25 °C)			
Sensor output operation	AC power supply	Speed	Output transistor operation	Output state
	OFF		OPEN	HIGH (Abnormal)
	ON	Below detection speed	OPEN	HIGH (Abnormal)
	ON	Above detection speed	CLOSE	LOW (Normal)
Detection speed RD	1500 ~ 2200 rpm			
Detection delay time TD	2 s or less 17 Type			
Type	Standard speed			
Insulation resistance	10 M Ω or higher by a DC 500 V: Between the sensor lead and venturi			
Dielectric strength	Between the sensor lead and venturi	No anomaly allowed after applying AC 500 V 50 Hz for 1 minute		

■ Sensor specification

■ Operational and handling precautions

Operate fans and blowers at an ambient temperature of between -10 °C and 60 °C and relative humidity of less than 90 %. Latch output is not used so malfunction by electrical noise can be ruled out. However, note that the semiconductor devices in the internal circuitry may be damaged by electrical noise and high voltage. No delay circuit is provided so a trouble signal is output on startup. As when operating and handling the fan, exercise caution to avoid dropping and exposing the blower to shock and vibration.

■ Sensor connection

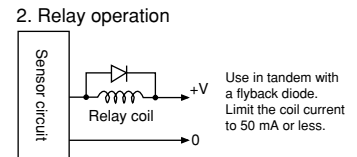
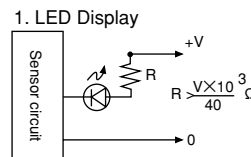

※ A sensor is available with the AS ad PL series only.