

Features

1. High torque
2. Low vibration
3. Silent operation
4. High position accuracy

The best magnetic balance is employed in our round type stepping motor. Motor performance is greatly improved using the latest technology of three dimensional magnetic field analysis and robust design.

Features (Compare to our current 42 & 56 square size motors)

Both high torque and low vibration performance were achieved.

- The round core provides the best magnetic balance. High torque performance is also achieved by optimizing the design with three dimensional magnetic field analysis. More than 30% higher holding torque was achieved and pull-out torque was also improved. (Refer to Fig. 1 and 2)

Fig. 1

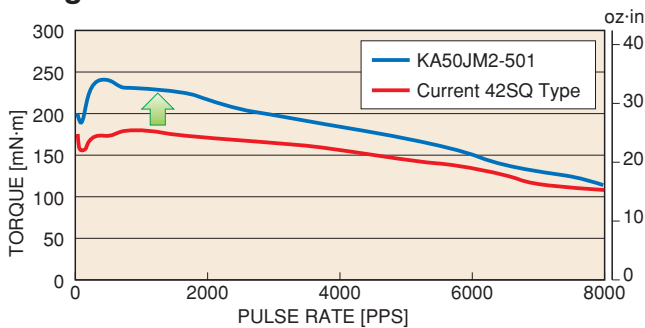
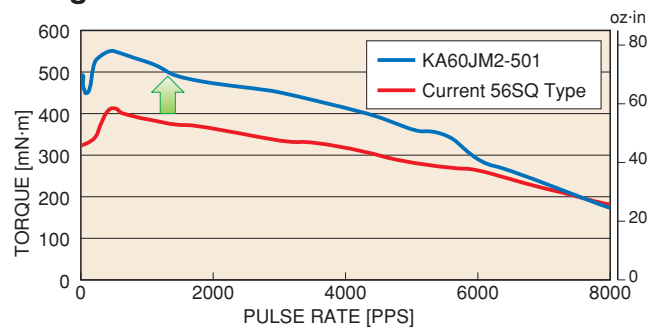
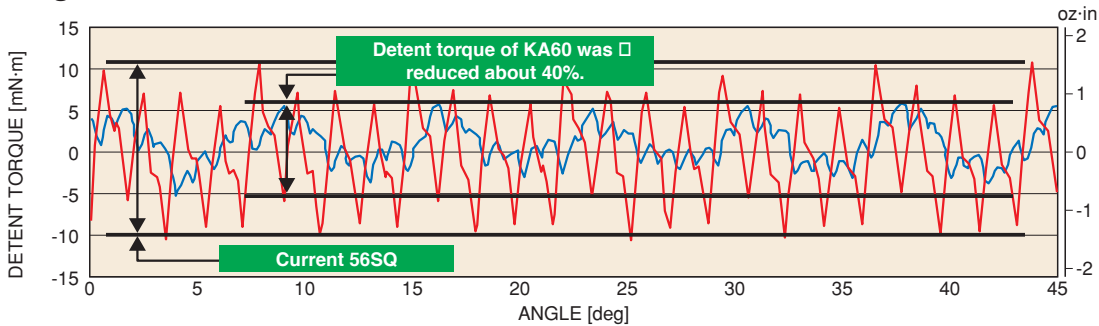

Fig. 2



- Low vibration and low rotational fluctuation were realized by reducing the detent torque using three dimensional magnetic field analysis. Rotational fluctuation was reduced about 30%.

Fig. 3



- Position accuracy was improved by minimizing the deviation of induced voltage. Position accuracy was improved about 30%. (Refer to Fig.4)

Fig. 4

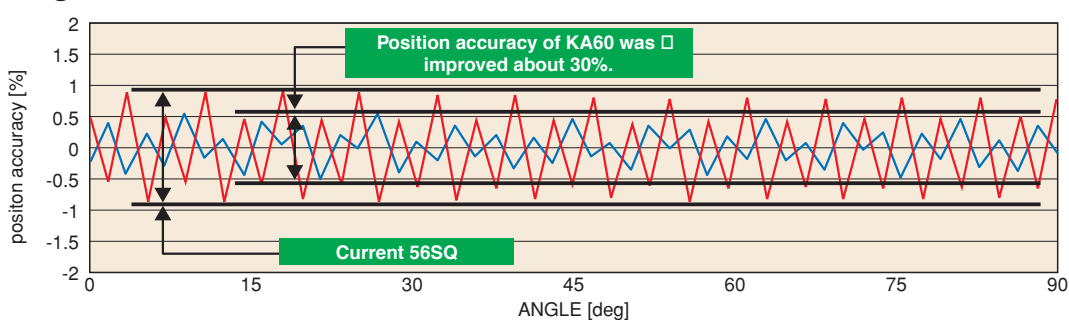

- Shaft size and mounting dimension compatibility between the 42sq. & KA50 and the 56sq. & KA60.
- Space Saving: High torque performance with shorter motor.
- All models are RoHS compliant.

- * Three dimensional magnetic field analysis: The magnetic strength is shown three dimensionally and the highest efficiency core shape is determined.
- * Robust design: A design method that is not influenced by the variation in parts to eliminate product performance variation.

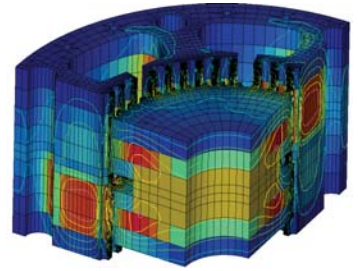

Max. Allowable Load / Runout for Motor Shaft

Load for Motor Shaft

Type	Thrust load	Radial load	
		Load	L
KA50	14.7 N [1.5 kgf] [3.3 lb]	19.6 N [2.0 kgf] [4.4 lb]	10 mm
KA60	40 N [4.1 kgf] [9.0 lb]	70 N [7.1 kgf] [15.8 lb]	

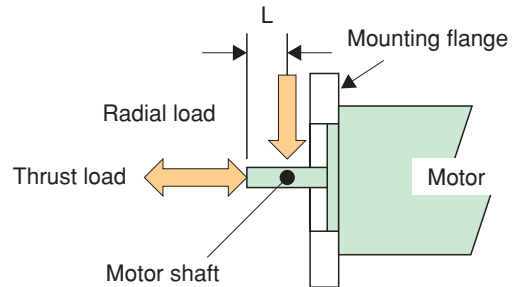

Shaft Run Out

Shaft run out	0.05 T.I.R. [mm]*
Concentricity between shaft and mounting circle	0.075 T.I.R. [mm]*
Perpendicularity between shaft and mounting face	0.075 T.I.R. [mm]*

* T.I.R. (Total Indicator Reading)

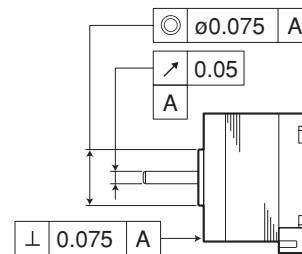

Specification

Temperature rise	70 K max (By resistance method)
Insulation class	Class E equivalent
Insulation resistance	100 M Ω min. At 500 V DC (at normal temp. & humidity, between lead and case)
Dielectric strength	500 V AC 50 Hz for 1 minute (at normal temp. & humidity, between lead and case)
Ambient temp. range	-10 °C ~ +50 °C
Storage temperature range	-20 °C ~ +70 °C
Humidity range in operation and storage	5 % ~ 95 % RH (noncondensing)

KA50 Series (0.9 degree/step)

High-resolution Motors

Standard Specifications

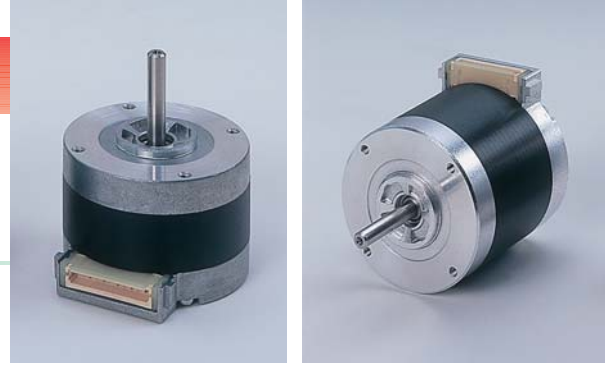

UNIPOLAR

Model	Step angle	Voltage	Current	Resistance	Inductance	Holding torque		Detent torque		Rotor inertia	
Dimension	degree/step	V/∅	A/∅	Ω/∅	mH/∅	mN·m	oz-in	mN·m	oz-in	g·cm ²	oz-in ²
KA50HM1-501	0.9	2.12	2.0	1.06	1.15	185	26	10	1.4	50	0.3
KA50HM1-502		4.20	1.0	4.20	4.40	185	26	10	1.4	50	0.3
KA50JM1-501		2.46	2.0	1.23	1.60	304	43	12	1.7	70	0.4
KA50JM1-502		5.00	1.0	5.00	6.90	304	43	12	1.7	70	0.4
KA50KM1-501		3.32	2.0	1.66	2.10	403	57	18	2.5	100	0.5
KA50KM1-502		6.70	1.0	6.70	8.60	403	57	18	2.5	100	0.5

BIPOLAR

Model	Step angle	Voltage	Current	Resistance	Inductance	Holding torque		Detent torque		Rotor inertia	
Dimension	degree/step	V/∅	A/∅	Ω/∅	mH/∅	mN·m	oz-in	mN·m	oz-in	g·cm ²	oz-in ²
KA50HM1-551	0.9	1.66	2.0	0.83	1.60	215	30	10	1.4	50	0.3
KA50HM1-552		3.20	1.0	3.20	6.60	215	30	10	1.4	50	0.3
KA50JM1-551		1.96	2.0	0.98	2.30	347	49	12	1.7	70	0.4
KA50JM1-552		3.80	1.0	3.80	9.10	347	49	12	1.7	70	0.4
KA50KM1-551		2.60	2.0	1.30	3.10	458	65	18	2.5	100	0.5
KA50KM1-552		5.10	1.0	5.10	11.00	458	65	18	2.5	100	0.5

Outline unit = mm (inch)

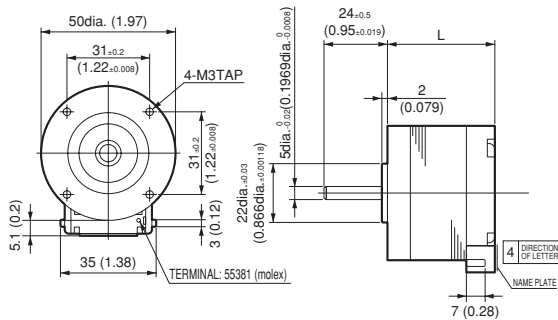

model	L[mm]	L[inch]	mass[g]	weight[lb]
KA50HM1	35	1.38	230	0.5
KA50JM1	40	1.57	300	0.7
KA50KM1	50	1.97	420	0.9

Accessories: Lead assy

UNIPOLAR

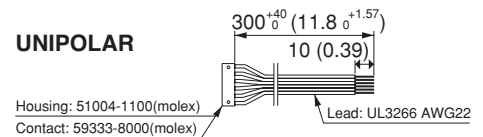

BIPOLAR

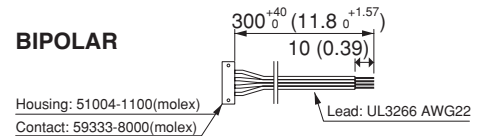

Connection Diagrams

Rotational direction

UNIPOLAR

(PHASE) 55381 PIN No. 55381 PIN No. (PHASE) CCW viewed from rotor shaft when using the following sequence diagram.

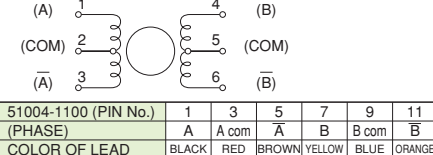

EXCITING SEQUENCE

55381 PIN No.	51004-1100 PIN No.	PHASE	1	2	3	4
1	1	A	-	-	-	-
4	7	B	-	-	-	-
3	5	A	-	-	-	-
6	11	B	-	-	-	-
2	3	A com	+	+	+	+
5	9	B com	+	+	+	+

BIPOLAR

(PHASE) 55381 PIN No. 55381 PIN No. (PHASE) CCW viewed from rotor shaft when using the following sequence diagram.

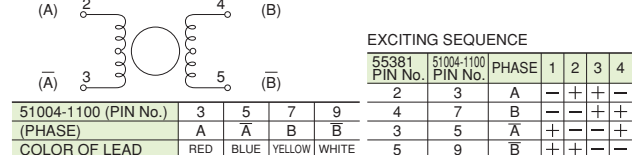

Speed-Torque Characteristics

UNIPOLAR

KA50HM1-501

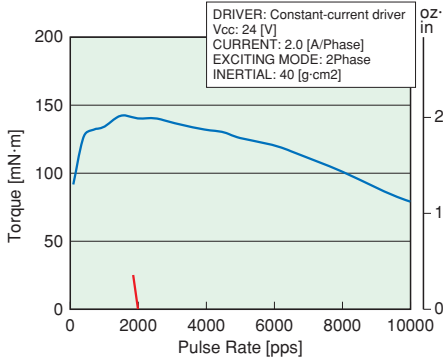

KA50JM1-501

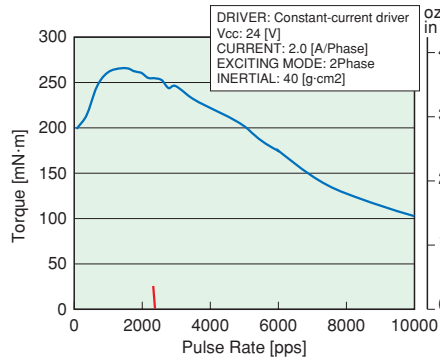

KA50KM1-501

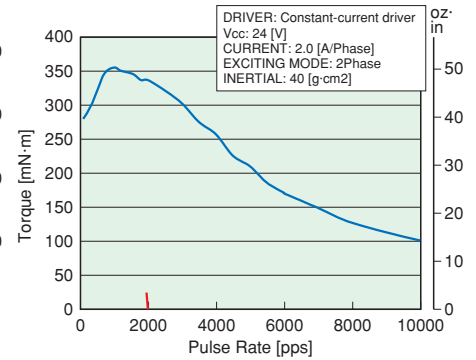

KA50HM1-502

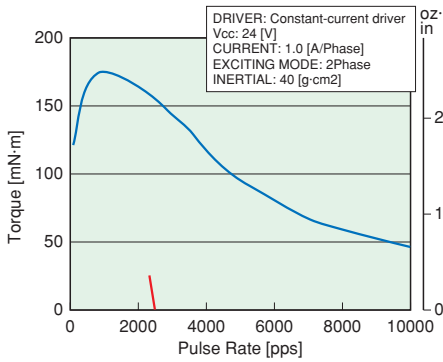

KA50JM1-502

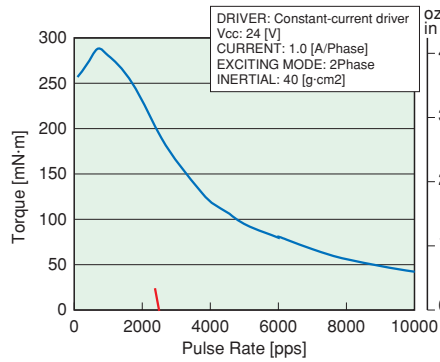

KA50KM1-502

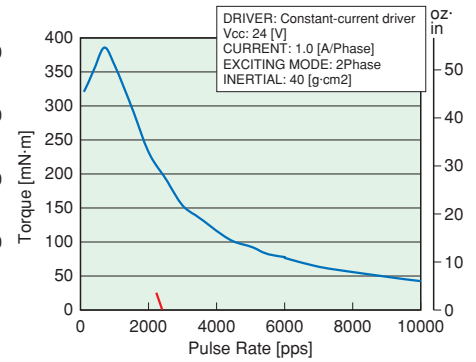

BIPOLAR

KA50HM1-551

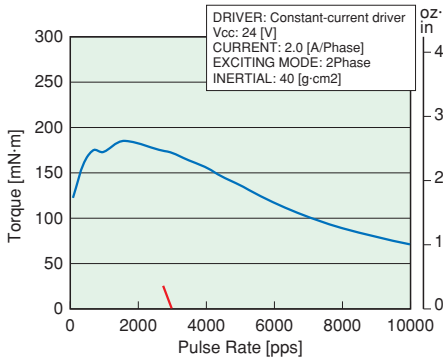

KA50JM1-551

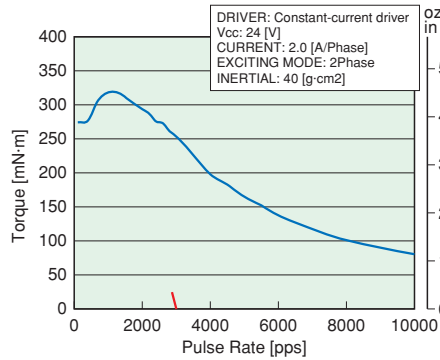

KA50KM1-551

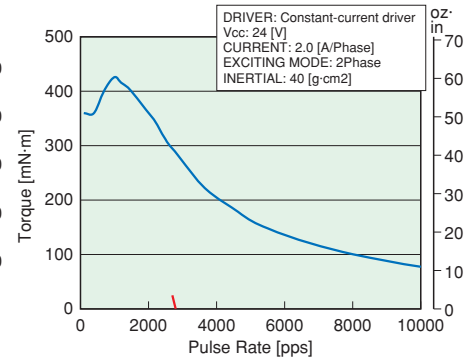

KA50HM1-552

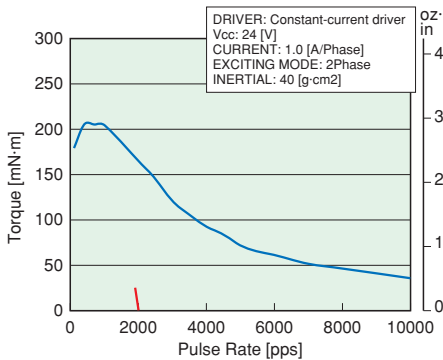

KA50JM1-552

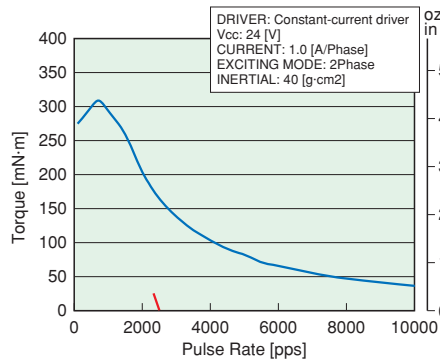

KA50KM1-552

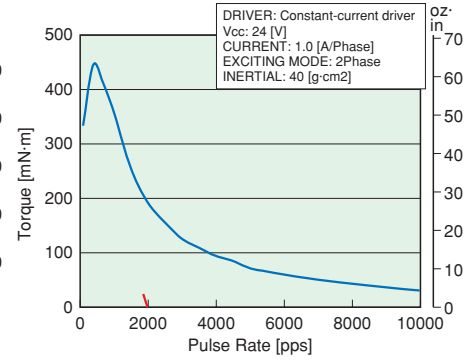

KA Series Semi-Standard

Motor with D-cut Single Shaft

(Model example)

KA50JM2-501 ⇒ KA50JM2-50101

Model List

	KA50 1.8 degree/step	KA60 1.8 degree/step	KA50 0.9 degree/step
UNIPOLAR	KA50HM2-50101	KA60JM2-50101	KA50HM1-50101
	KA50HM2-50201	KA60JM2-50201	KA50HM1-50201
	KA50JM2-50101	KA60KM2-50101	KA50JM1-50101
	KA50JM2-50201	KA60KM2-50201	KA50JM1-50201
	KA50KM2-50101	KA60LM2-50101	KA50KM1-50101
BIPOLAR	KA50HM2-55101	KA60JM2-55101	KA50HM1-55101
	KA50HM2-55201	KA60JM2-55201	KA50HM1-55201
	KA50JM2-55101	KA60KM2-55101	KA50JM1-55101
	KA50JM2-55201	KA60KM2-55201	KA50JM1-55201
	KA50KM2-55101	KA60LM2-55101	KA50KM1-55101
KA50KM2-55201	KA60LM2-55201	KA50KM1-55201	

The basic motor characteristics, connection diagrams, and accessories (lead connectors) conform to the standard specifications.

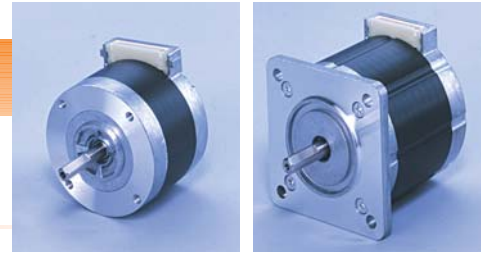

Outline unit = mm (inch) Single shaft specification

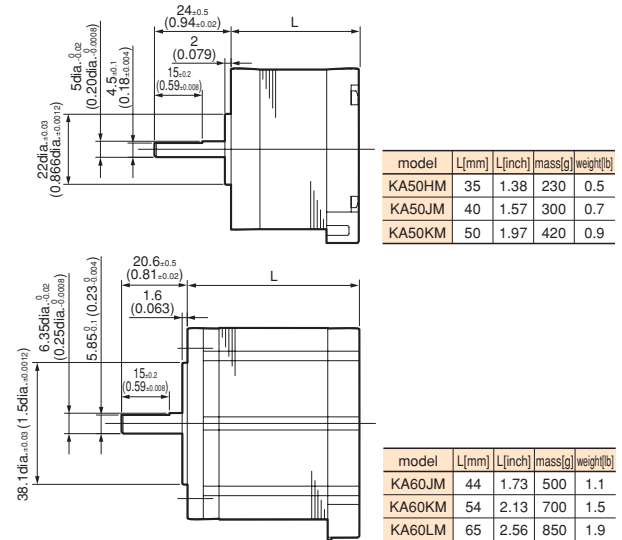

Motor with D-cut Double Shaft

(Model example)

UNIPOLAR KA50JM2-501 ⇒ KA50JM2-511

BIPOLAR KA50JM2-551 ⇒ KA50JM2-561

Model List

	KA50 1.8 degree/step	KA60 1.8 degree/step	KA50 0.9 degree/step
UNIPOLAR	KA50HM2-511	KA60JM2-511	KA50HM1-511
	KA50HM2-512	KA60JM2-512	KA50HM1-512
	KA50JM2-511	KA60KM2-511	KA50JM1-511
	KA50JM2-512	KA60KM2-512	KA50JM1-512
	KA50KM2-511	KA60LM2-511	KA50KM1-511
BIPOLAR	KA50HM2-561	KA60JM2-561	KA50HM1-561
	KA50HM2-562	KA60JM2-562	KA50HM1-562
	KA50JM2-561	KA60KM2-561	KA50JM1-561
	KA50JM2-562	KA60KM2-562	KA50JM1-562
	KA50KM2-561	KA60LM2-561	KA50KM1-561
KA50KM2-562	KA60LM2-562	KA50KM1-562	

The basic motor characteristics, connection diagrams, and accessories (lead connectors) conform to the standard specifications.

Outline unit = mm (inch) Double shaft specification

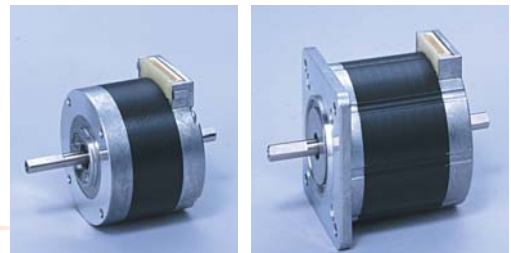
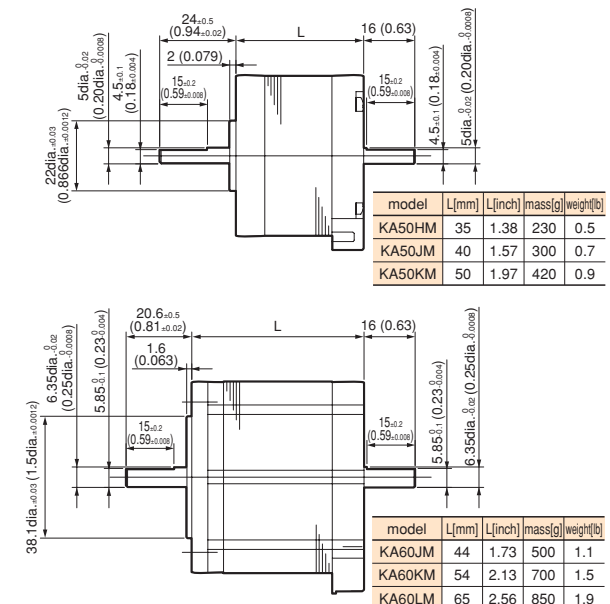

Motor with Encoder

(Model example)

KA50JM2-501 ⇒ 2 Channel KA50JM2E2-501

3 Channel KA50JM2E3-501

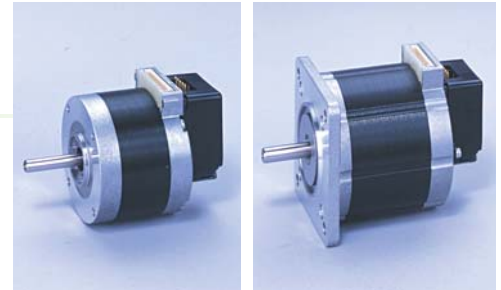

Model List

	KA50 1.8 degree/step			KA60 1.8 degree/step		
	Base motor	2 Channel	3 Channel	Base motor	2 Channel	3 Channel
UNIPOLAR	KA50HM2-501	KA50HM2E2-501	KA50HM2E3-501	KA60JM2-501	KA60JM2E2-501	KA60JM2E3-501
	KA50HM2-502	KA50HM2E2-502	KA50HM2E3-502	KA60JM2-502	KA60JM2E2-502	KA60JM2E3-502
	KA50JM2-501	KA50JM2E2-501	KA50JM2E3-501	KA60KM2-501	KA60KM2E2-501	KA60KM2E3-501
	KA50JM2-502	KA50JM2E2-502	KA50JM2E3-502	KA60KM2-502	KA60KM2E2-502	KA60KM2E3-502
	KA50KM2-501	KA50KM2E2-501	KA50KM2E3-501	KA60LM2-501	KA60LM2E2-501	KA60LM2E3-501
	KA50KM2-502	KA50KM2E2-502	KA50KM2E3-502	KA60LM2-502	KA60LM2E2-502	KA60LM2E3-502
BIPOLAR	KA50HM2-551	KA50HM2E2-551	KA50HM2E3-551	KA60JM2-551	KA60JM2E2-551	KA60JM2E3-551
	KA50HM2-552	KA50HM2E2-552	KA50HM2E3-552	KA60JM2-552	KA60JM2E2-552	KA60JM2E3-552
	KA50JM2-551	KA50JM2E2-551	KA50JM2E3-551	KA60KM2-551	KA60KM2E2-551	KA60KM2E3-551
	KA50JM2-552	KA50JM2E2-552	KA50JM2E3-552	KA60KM2-552	KA60KM2E2-552	KA60KM2E3-552
	KA50KM2-551	KA50KM2E2-551	KA50KM2E3-551	KA60LM2-551	KA60LM2E2-551	KA60LM2E3-551
	KA50KM2-552	KA50KM2E2-552	KA50KM2E3-552	KA60LM2-552	KA60LM2E2-552	KA60LM2E3-552

Outline unit = mm (inch)

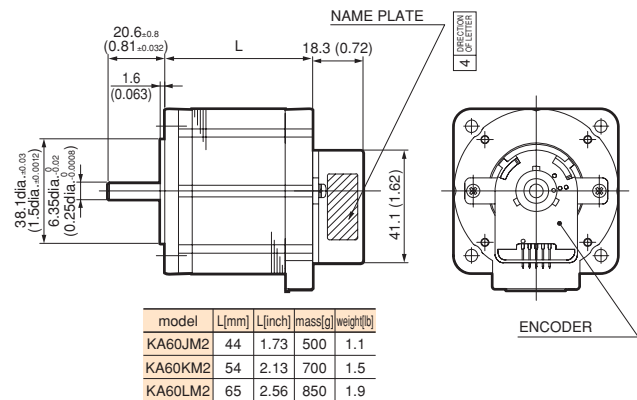
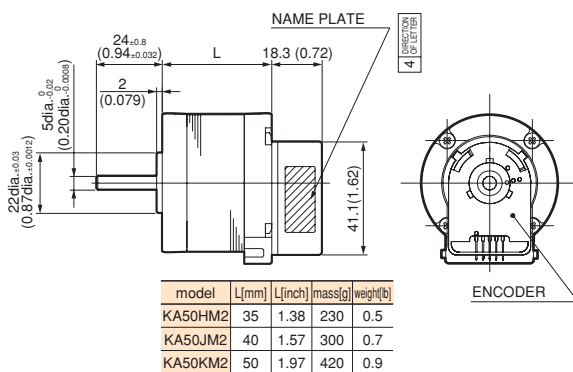

Encoder specification

	KA50, KA60
Resolution [P/R]	400
Power-supply voltage	DC 5V ±0.5 V
Output aspect	2 Channel (A, B aspect) or 3 Channel (A, B, I aspect)
Output wave form	TTL

Recommended pull-up resistor value

	2 Channel	3 Channel
R [Ω]	11 k	2.7 k

The basic motor characteristics, connection diagrams, and accessories (lead connectors) conform to the standard specifications.

Connection diagrams

2 Channel

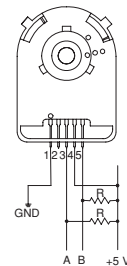

PIN No.	1	2	3	4	5
Connection	GND	—	A aspect	+5 V	B aspect

3 Channel

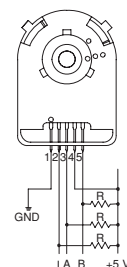

PIN No.	1	2	3	4	5
Connection	GND	I aspect	A aspect	+5 V	B aspect