

DC Silent Fan

DC
SILENT 25



□120×25 (□4.7"×1.0")
Max. airflow: 2.4 m³/min
Max. static pressure: 57 Pa
Mass: 230 g

Fan model code

- SCUD12B4
- SCUD12B4P
- SCUD12B4S
- SCUD12B4SQ
- SCUD12D4
- SCUD12D4S
- SCUD24B4
- SCUD24B4P
- SCUD24B4S
- SCUD24D4
- SCUD24D4S

Standard specification

Max. Airflow m ³ /min	Max. Static Pressure CFM	Max. Static Pressure Pa	Noise inH ₂ O	Noise dB	Speed min ⁻¹	Input W	Voltage Spec. V		Current mA		Model Code	Operating Temp. Range °C
							Rating	Operating Range	Rating	Starting		
2.4	85	57	0.23	39	2650	4.5	12	7.2-13.8	380	740	SCUD12B4	-20 ~ +60
							24	12-27.6	200	390	SCUD24B4	
1.7	60	33	0.13	31	1950	2	12	8.4-13.8	170	380	SCUD12D4	
							24	14.4-27.6	90		SCUD24D4	

- Figures in the table are average measured values. Please request the product delivery specification when preparing a purchase specification.
- The characteristics are the values at rated voltage (12 V or 24 V), and normal temperature and humidity.

General specification

Materials Used	Venturi: Aluminum alloy die castings Propeller: ABS and PBT synthetic resins Bearing: Both side shielded ball bearing
Motor	Brushless DC motor, Protection type: Current shut off by detecting lock state, automatically reset
Common Elec. Spec.	See pages G-11, G-12, G-13.
Standard Carton	30 to a carton of (450 x 380 x 160) mm, mass 7.5 kg

Guard mounting

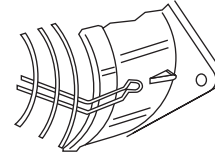

The guard for the intake side (SCU guard) can be mounted with one touch without using a tool.

Standard airflow and static pressure characteristics (At rated voltage)

[By double chamber method]

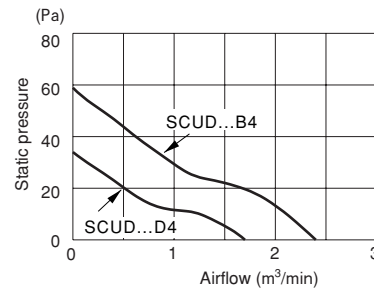

External dimensions in mm (inches)

Lead wire type

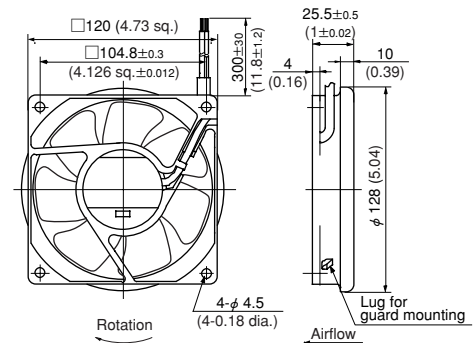

Lead wire spec. AWG24 UL1007 or UL3266
Color (+) Red
(-) Black (SCUD□D4: Blue)

Wiring connection diagram

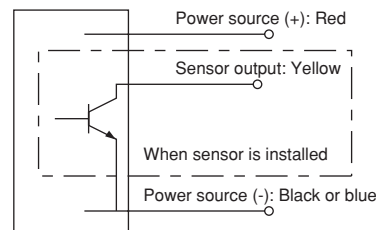

Mounting hole dimensions in mm (inches)
[Recommendation]

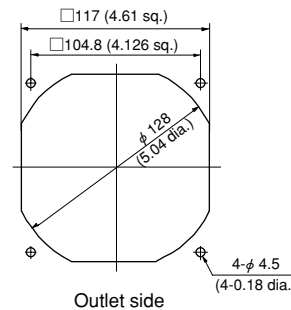

Options (sold separately)

- Guard: F120UL guard (Outlet side)
- Guard: SCU guard (Intake side)

DC axial fan with sensor

Rated Voltage	Model Code	
12 V	SCUD12D4S	SCUD12B4S
		SCUD12B4P
		SCUD12B4SQ
24 V	SCUD24D4S	SCUD24B4S
		SCUD24B4P

- Japan Servo can meet many of your requirements for customization, such as special connectors, other sensors not listed above, variable speed specifications, and other modifications. Please contact Japan Servo during your product planning and development stage.
- The listed products are registered in the following overseas standards files, UL: E48889, CSA: LR49399, TUV: R9451586
- An electronic version of the Japan Servo catalog can be forwarded upon request. 3D data is also available at our web2-CAD site (www.web2cad.co.jp).

F60P Guard (Mass 4 g)

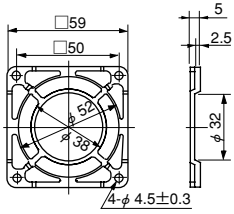

Material: Polycarbonate (black)
UL94V-2

F60UL Guard (Mass 12 g)

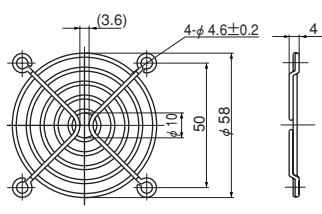

Material: Mild steel wire 1.6 dia.
Surface treatment:
Nickel chromium plating

F80UL Guard (Mass 14 g)

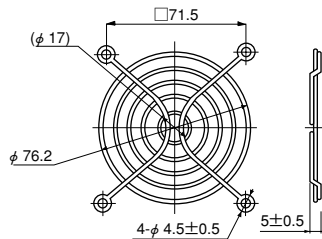

Material: Mild steel wire 1.6 dia.
Surface treatment:
Nickel chromium plating

F92UL Guard (Mass 16 g)

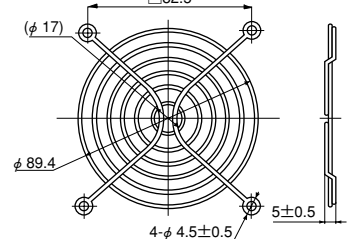

Material: Mild steel wire 1.6 dia.
Surface treatment:
Nickel chromium plating

F120UL Guard (Mass 29 g)

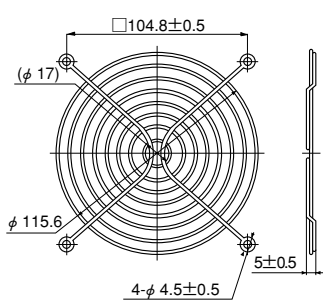

Material: Mild steel wire 1.6 dia.
Surface treatment:
Nickel chromium plating

F127UL Guard

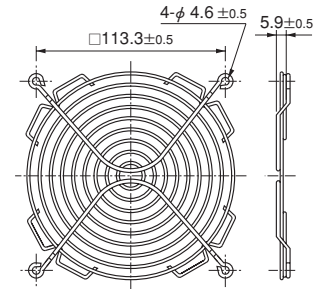

Material: Mild steel wire 1.6 dia.
Surface treatment:
Nickel chromium plating

GUARD 172

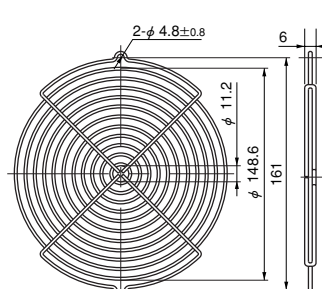

Material: Mild steel wire 2 dia.
Surface treatment:
Nickel chromium plating

F180UL Guard

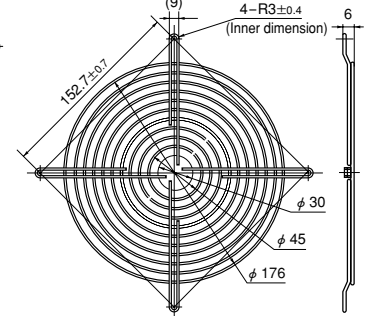

Material: Mild steel wire 1.6 dia.
Surface treatment:
Nickel chromium plating

F200UL Guard (Mass 82 g)

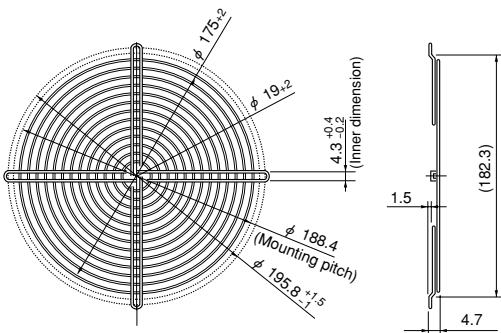

Material: Mild steel wire 1.6 dia.
Surface treatment:
Nickel chromium plating

SCU Guard (Mass 50 g)

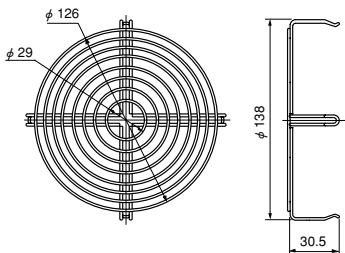

Material: Mild steel wire 1.6 dia.
Surface treatment:
Nickel chromium plating

SCN Guard (Mass 55 g)

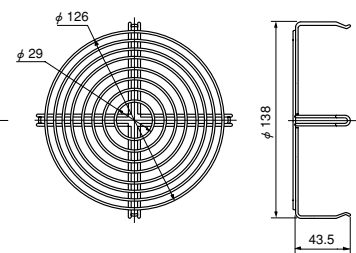

Material: Mild steel wire 1.6 dia.
Surface treatment:
Nickel chromium plating

• Guard special for intake side of SCUD (metal venturi) fans.

• Guard special for intake side of SCND (metal venturi) fans.

List of mating fan series

Guard	F60P	F60UL	F80UL	F92UL	F120UL	F127UL	GUARD 172	F180UL	F200UL	SCN	SCU
SCU					○*1						○*2
SCN					○*1					○*2	
VE			○								
WE				○							
KA				○							
CU					○						
CN					○						
MA							○				
PA							○				
PL								○			
SKUD				○							
SKLD				○							
SCUD					○*1						○*2
SCND					○*1					○*2	
SCUDM					○						
SCNDM					○						
TUDC	○	○									
PUDC			○								
KUDC				○							
KLDC				○							
CUDC					○						
CNDC					○						
D1238					○						
D1338						○					
MADC							○				
PADC							○				
G1751							○				
SADC								○			

*1: Can be installed only on outlet side. *2: Can be installed only on intake side.
All guards conform to the UL standard when combined with Japan Servo fans.
The installation of a filter, guard and other accessories will constitute a ventilating load, reducing the airflow. Select a suitable guard, taking into consideration the increase in air resistance. (See Figs. 12 and 13 on page G-7.)

Filter

3-piece set

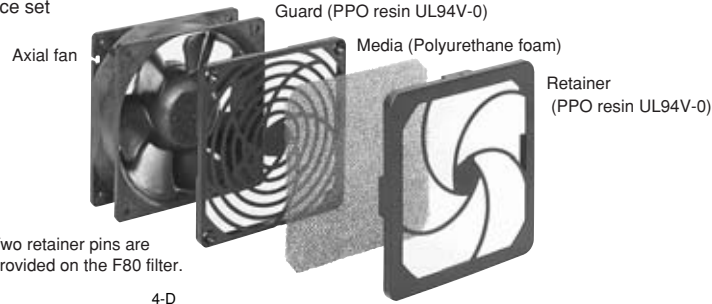

Note: Two retainer pins are provided on the F80 filter.

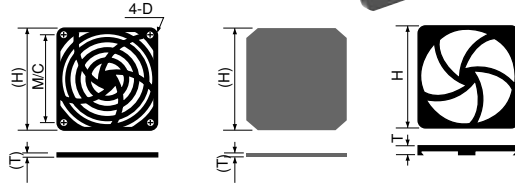

List of mating fan series

Filter	F80	F92	F120
DC Axial Fans	SKUD	○	
	SKLD	○	
	SCUDM		○
	SCNDM		○
	KUDC	○	
	PUDC	○	
	KLDC	○	
	CUDC		○
	CNDH		○
	D1238		○

Filter	F80	F92	F120	
AC Axial Fans	VE	○		
	WE		○	
	KA		○	
	CU			○
	CN			○

Component (Model Code)	H	T	M/C	D
F80 Filter	83.6	10	71.5	φ 3.8
F92 Filter	96.5	10	82.5	φ 3.8
F120 Filter	123.7	10.7	104.8	φ 4.6

Flange spacer

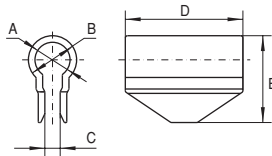

Component (Model Code)	A mm	B mm	C mm	D mm	E mm	Mating Model Code
Flange Spacer PUDC (※)	5	8	2	17	14.5	KUDC,PUDC
Flange Spacer CUDC (※)	8	11	3.5	15	19.8	CUDC
Flange Spacer CNDC	8	11	3.5	28	19.8	CNDC

※Ribbed venturis (PUDC-R, CUDC-R) are available for PUDC and CUDC.

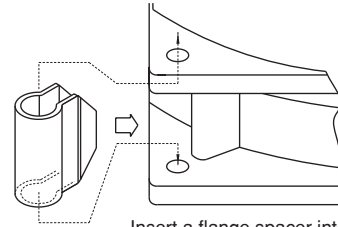

Insert a flange spacer into the ribs of a venturi.

(Installing a flange spacer)

Inlet ring

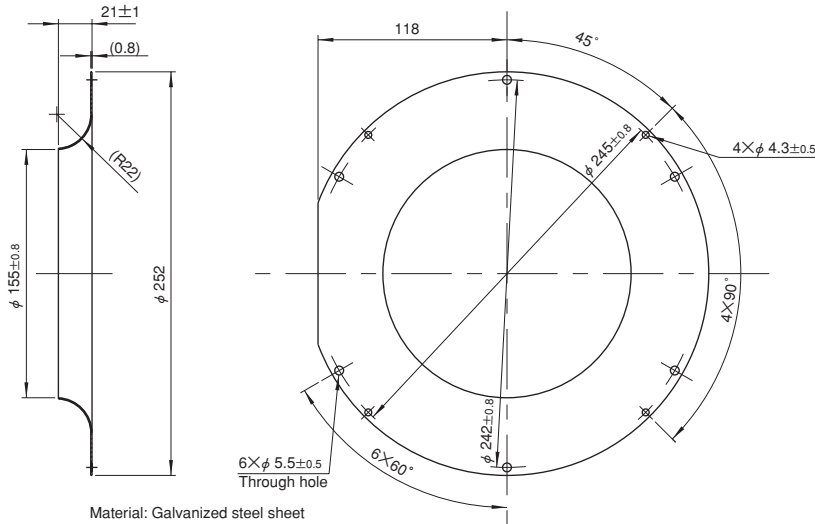

Material: Galvanized steel sheet

Component (Model Code)	Mating Model Code
E2271 Inlet ring	E2271Z

Plug cords for AC fans

(Common specification: Rated 3 A, voltage 250 V, dielectric strength 1 minute at 1500 V 50 Hz)

D2P1 cord (Mass 35 g)

Certified under the Electrical Appliance and Material Safety Law (Japan) (<PS>E mark approved)
Cord 0.18 dia. 30 conductors Black, heat resistant vinyl

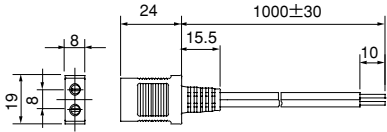

UL2P1 cord (Mass 41 g)

UL standard product (UL file No. E78112)
Cord 0.16 dia. 41 conductors Black, heat resistant vinyl

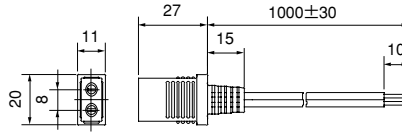

* UL2P2 cord with 2m length also available.

T2P1 cord

For wiring inside equipment
Cord 0.18 dia. 30 conductors Black, heat resistant vinyl

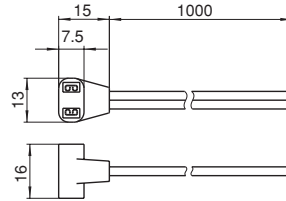

D3P1 cord (Mass 59 g)

Certified under the Electrical Appliance and Material Safety Law (Japan) (<PS>E mark approved)
Cord:

For power feeding 0.18 dia. 30 conductors Black, heat resistant vinyl
For grounding 0.18 dia. 50 conductors Black, heat resistant vinyl

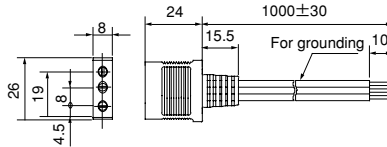

UL3P1 cord (Mass 60 g)

UL standard product (UL file No. E78112)
Cord:

For power feeding 0.16 dia. 41 conductors Black, heat resistant vinyl
For grounding AWG18 green/yellow spiral, heat resistant vinyl

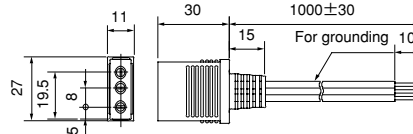

* UL3P2 cord with 2 m length also available.

PL sensor 1 cord

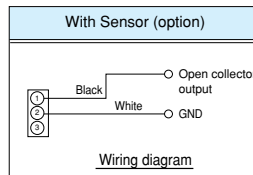
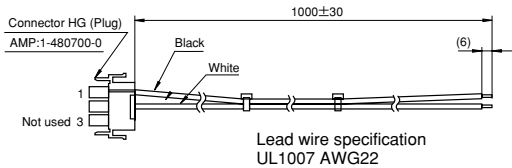

PL4P1 cord

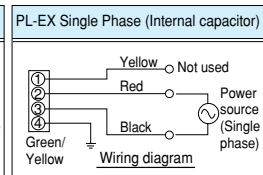
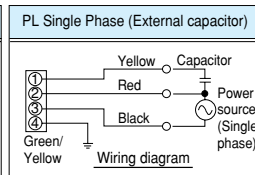
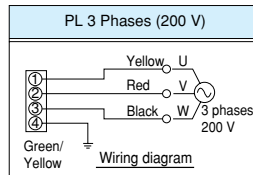
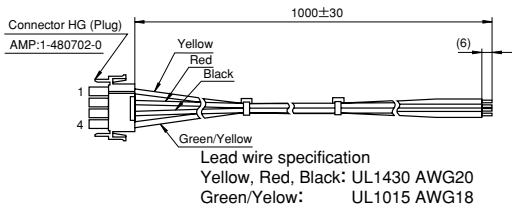

List of mating fan series

Cord	T2P1	D2P1	D3P1	UL2P1	UL3P1	PL4P1	PL sensor
WE	○	○		○			
KA	○	○		○			
CU	○	○		○			
CN (2 terminals)	○	○		○			
CN (3 terminals)			○		○		
MA	○	○		○			
PA	○	○		○			
PL						○	○

Plug cords for DC fans

DCLD030ST-ZZ01 (S sensor output cord)

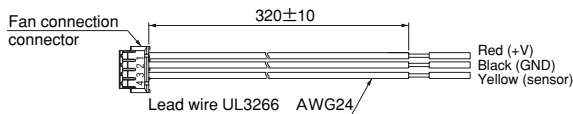

DCLD030PT-ZZ01 (P sensor output cord)



• Lead wire ends are sheathed to protect conductors. (Sheath peeling dimension 10±5)

Component (Model Code)	Mating Model Code
DCLD030ST-ZZ01	E1033H□□B□AM-04
DCLD030PT-ZZ01	

DC axial fans & blowers with sensors

The DC fans and blowers of Japan Servo have a function to send an alarm signal when the fan motor revolutions slow down. Several systems are used to cut off the system power supply by this alarm signal, with three types of sensors available. Select the right type of sensor in accordance with the purpose of use. The lead wire for the sensor is yellow. The output type is an open collector output for all three types.

■ Sensor type

1. Lock detection type (Product code: S)

The output signal indicates an [L] state (transistor is ON) while the propeller is rotating, changing to an [H] state (transistor is OFF) less than five seconds after the propeller stops rotating. The propeller automatically restarts operation within five seconds when the lock is unlocked. ([H] → [L] 5 s). If the pull-up voltage is live, the [H] state (transistor is OFF) will engage in less than five seconds, even when the power is turned off.

- Specification: $V_{CE} = 28\text{ V max}$ (55.2 V max for 48 V products)
 $I_C = 5\text{ mA max}$
($V_{CE(SAT)} = 0.4\text{ V max}$)
- Output waveform

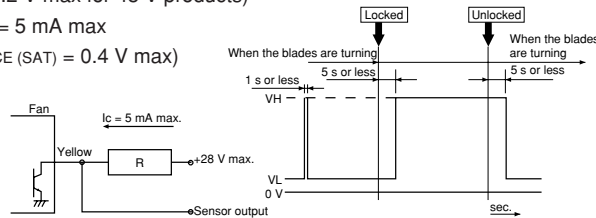

※When the power is turned on, the state sometimes becomes high [H] for several hundred ms.

2. Pulse output type (Product code: P)

A rectangular wave of two pulses will be output for each turn of the propeller while the propeller is rotating, outputting two types of signal depending on the propeller position when the propeller is locked. (See the note below ※)

- Specification: $V_{CE} = 28\text{ V max}$ (55.2 V max for 48 V products)
 $I_C = 5\text{ mA max}$
($V_{CE(SAT)} = 0.4\text{ V max}$)
- Output waveform

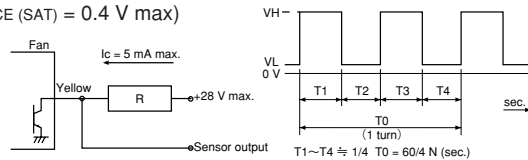

※Output signal waveform when the fan is stopped: The following two types of waveform are output, depending on the blade position when the propeller is stopped:
Pulse outputs of High - constant or restart timing (0.05 Hz to 2 Hz).

3. Speed detection type (Product code: Q)

The output signal indicates the [H] state when the propeller revolutions are slower than the preset speed, changing to the [L] state when the propeller revolutions exceed the reset speed.

[Products with a reversed output waveform are also available, suitable for a wired OR connection when several fans are installed. Contact Japan Servo for further information. {Former code: SQ, new code (15 - digit code products): R}]

- Specification: $V_{CE} = 28\text{ V max}$ (55.2 V max for 48 V products)
 $I_C = 5\text{ mA max}$
($V_{CE(SAT)} = 0.4\text{ V max at } 5\text{ mA}$)
- Output waveform

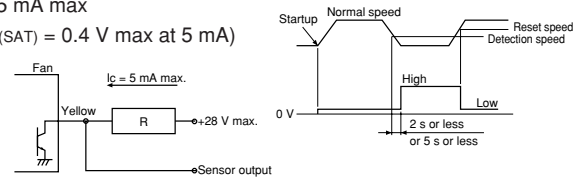

Note: The output waveform for type SQ (R) will be reversed. The speed setting for the alarm output is about half the rated speed. For more detailed information, please request a product delivery specification from Japan Servo.

AC fans with sensors

By equipping the motor with a rotation detection function, the AC fans of Japan Servo have a system to send an alarm signal when the fan motor revolutions slow down and to cut off the system power supply. In 1980, Japan Servo developed a system to output an alarm signal by detecting the lowering of generated voltage by installing a tachometer generator with the cooling fan and this system has since been incorporated in Japan Servo products. The output type of the alarm signal is an open collector output.

■ Sensor specification

Type	Tachometer generator type			
Sensor output operation	Open collector transistor, permissible sync Current: 50 mA max. Permissible imposed voltage: DC 40 V max. Permissible power consumption: 1.5 W max. (at 25 °C)			
Sensor output operation	AC power supply	Speed	Output transistor operation	Output state
	OFF		OPEN	HIGH (Abnormal)
	ON	Below detection speed	OPEN	HIGH (Abnormal)
	ON	Above detection speed	CLOSE	LOW (Normal)
Detection speed RD	1500 ~ 2200 rpm			
Detection delay time TD	2 s or less 17 Type			
Type	Standard speed			
Insulation resistance	10 M Ω or higher by a DC 500 V: Between the sensor lead and venturi			
Dielectric strength	Between the sensor lead and venturi	No anomaly allowed after applying AC 500 V 50 Hz for 1 minute		

■ Operational and handling precautions

Operate fans and blowers at an ambient temperature of between -10 °C and 60 °C and relative humidity of less than 90 %. Latch output is not used so malfunction by electrical noise can be ruled out. However, note that the semiconductor devices in the internal circuitry may be damaged by electrical noise and high voltage. No delay circuit is provided so a trouble signal is output on startup. As when operating and handling the fan, exercise caution to avoid dropping and exposing the blower to shock and vibration.

■ Sensor connection

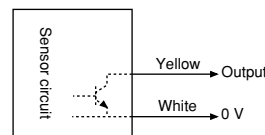

1. LED Display

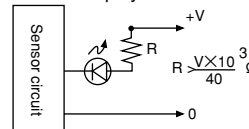

2. Relay operation

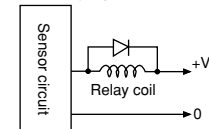

Use in tandem with a flyback diode. Limit the coil current to 50 mA or less.

※ A sensor is available with the AS ad PL series only.